



osmose wasserfilter

# Osmoflow Nano



# Anleitung



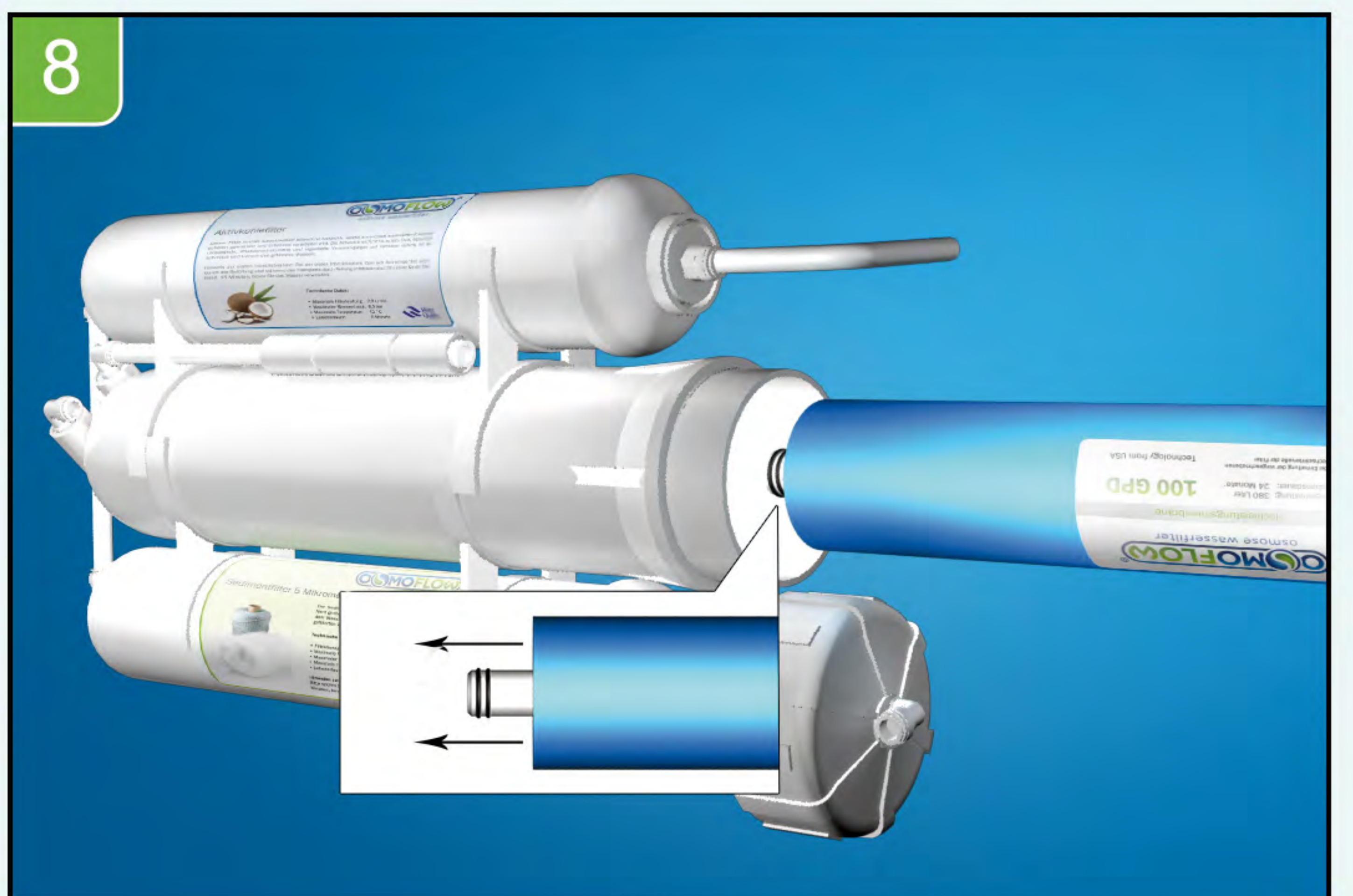
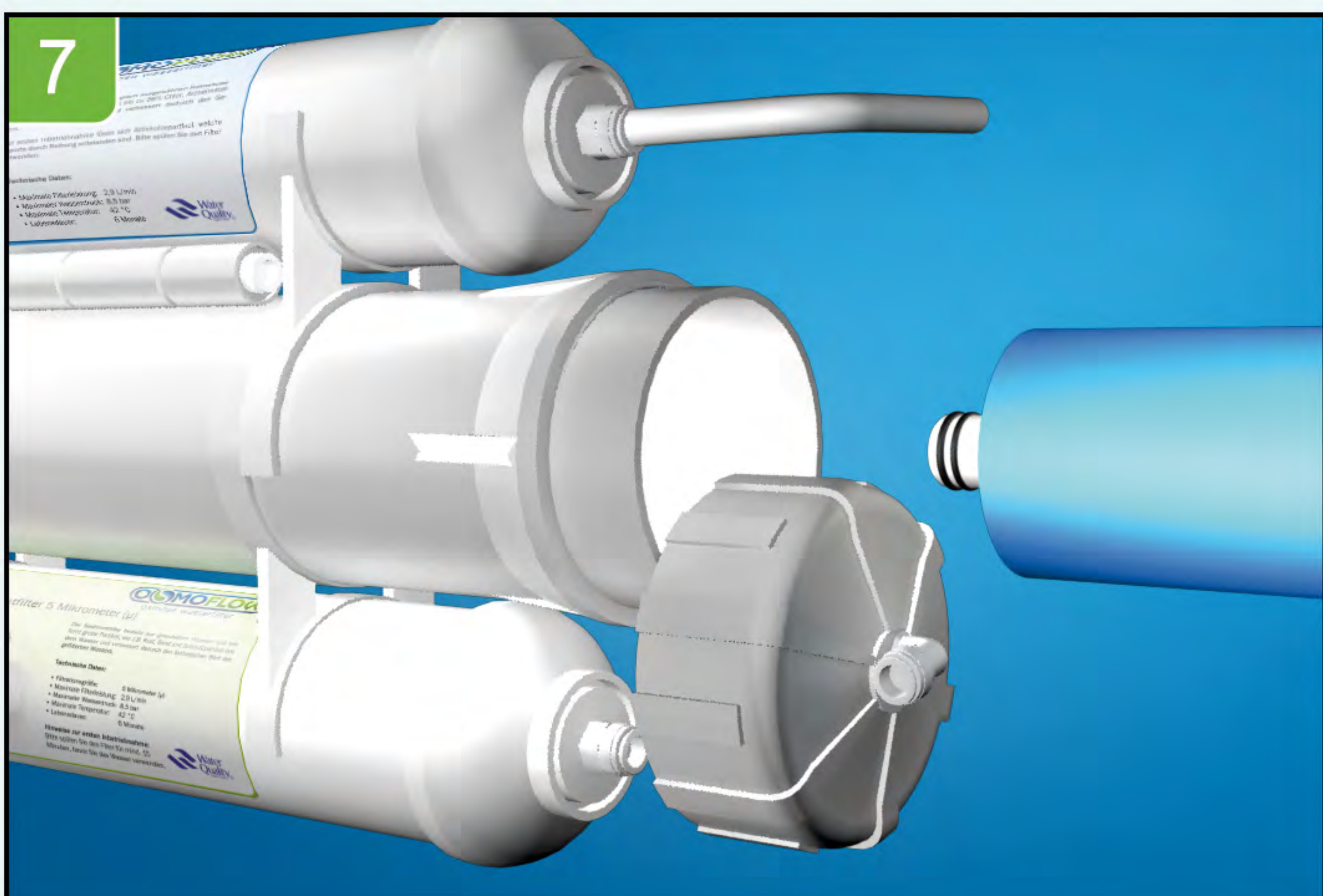
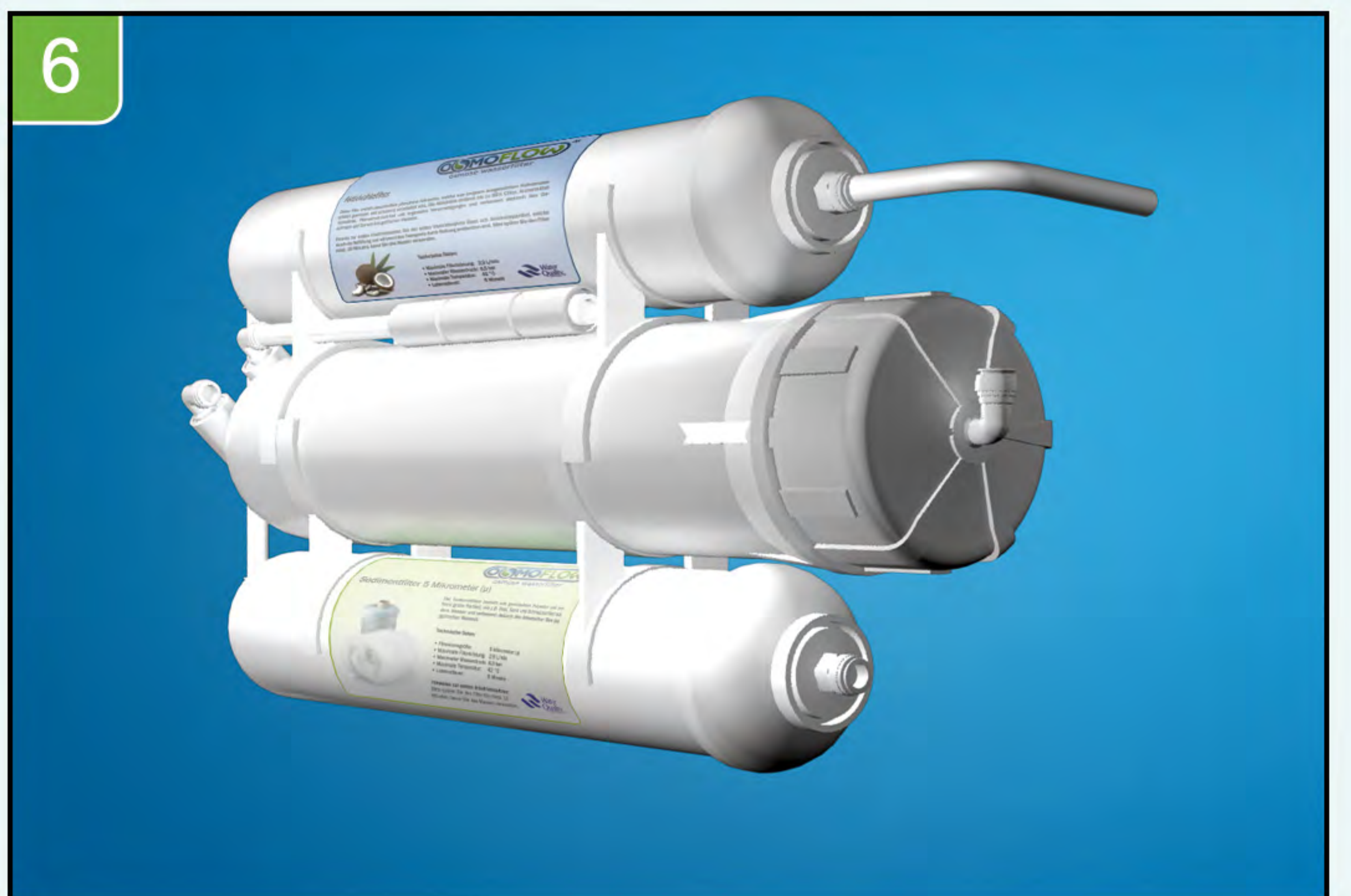
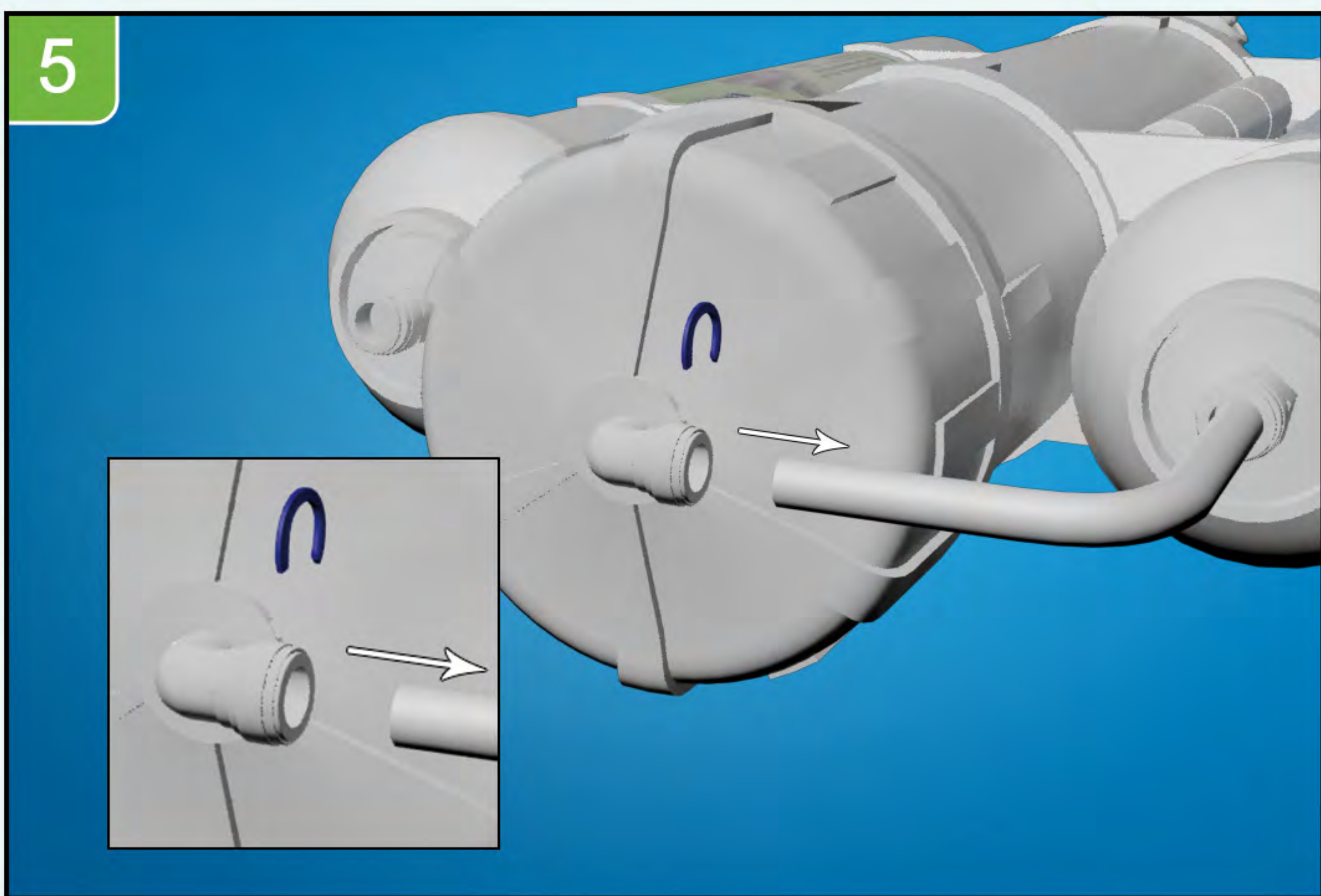
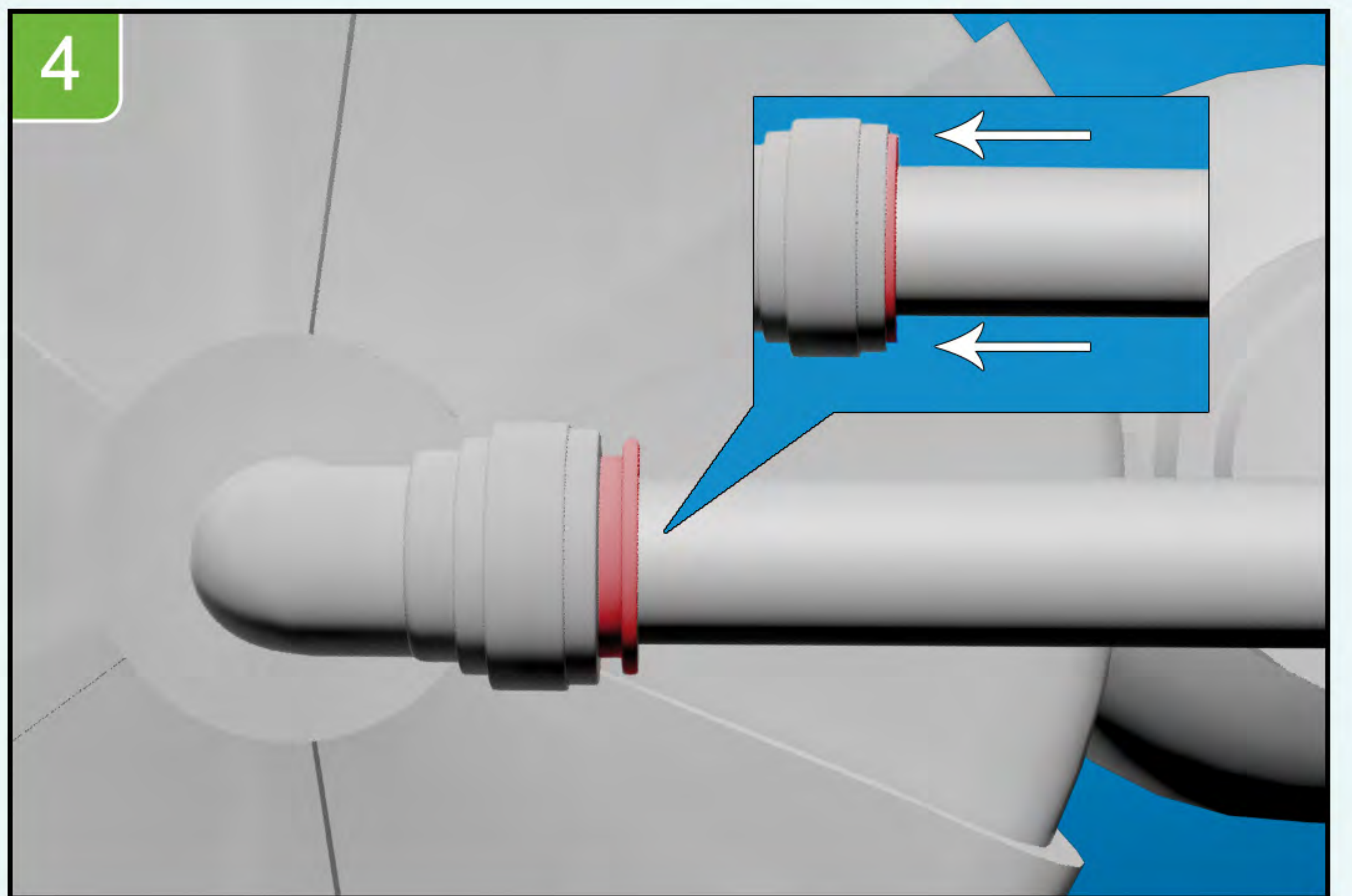
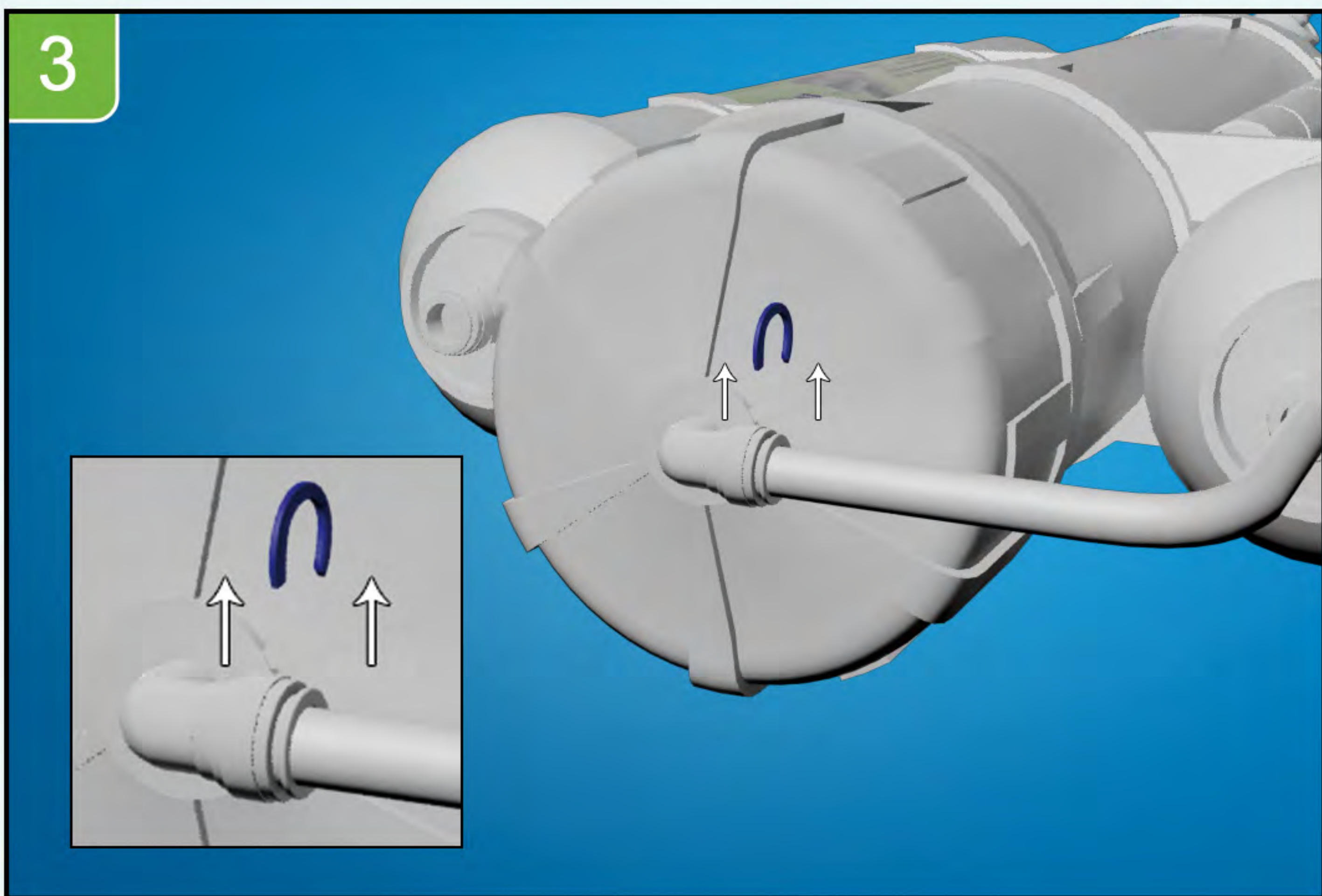
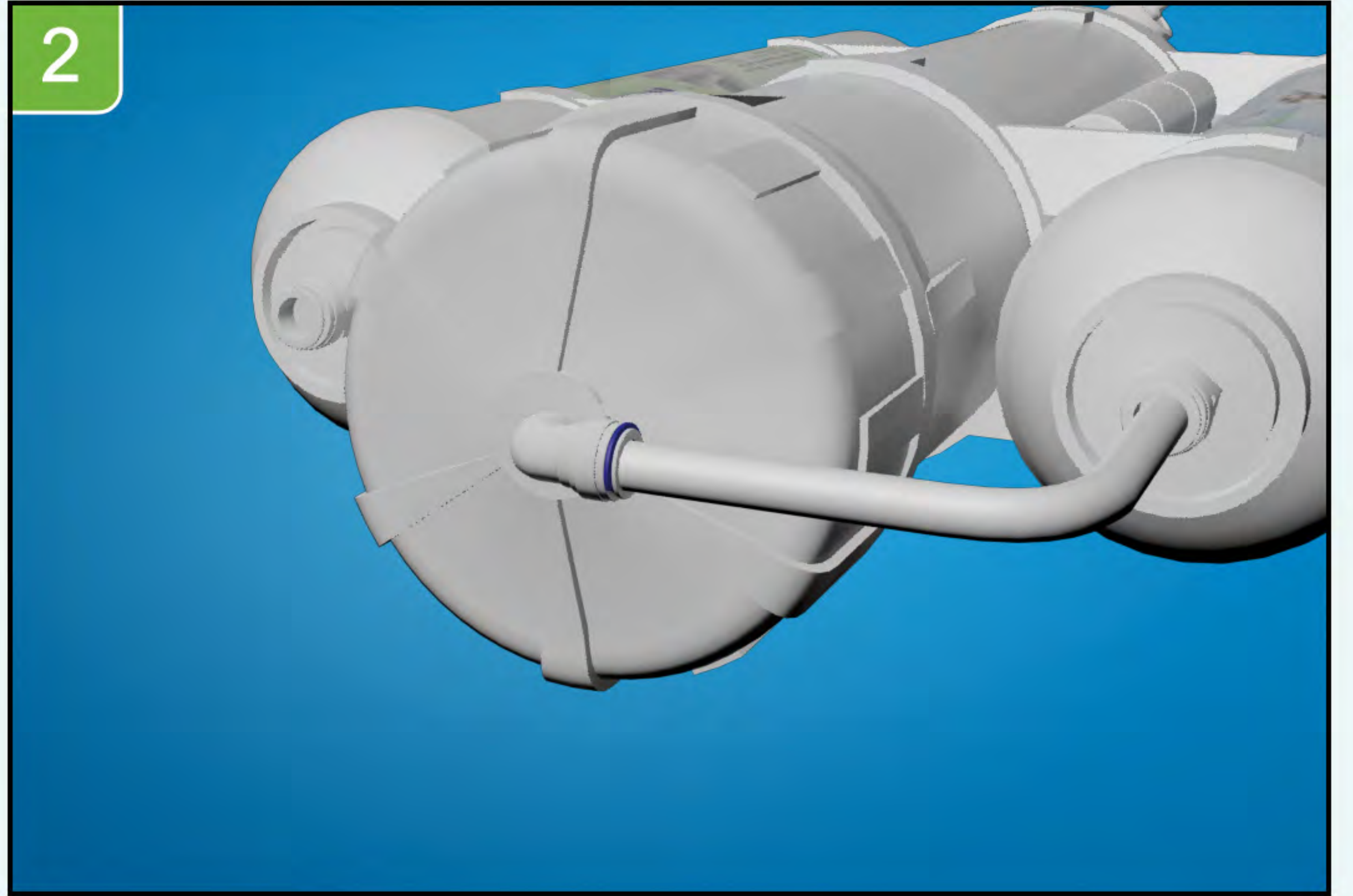



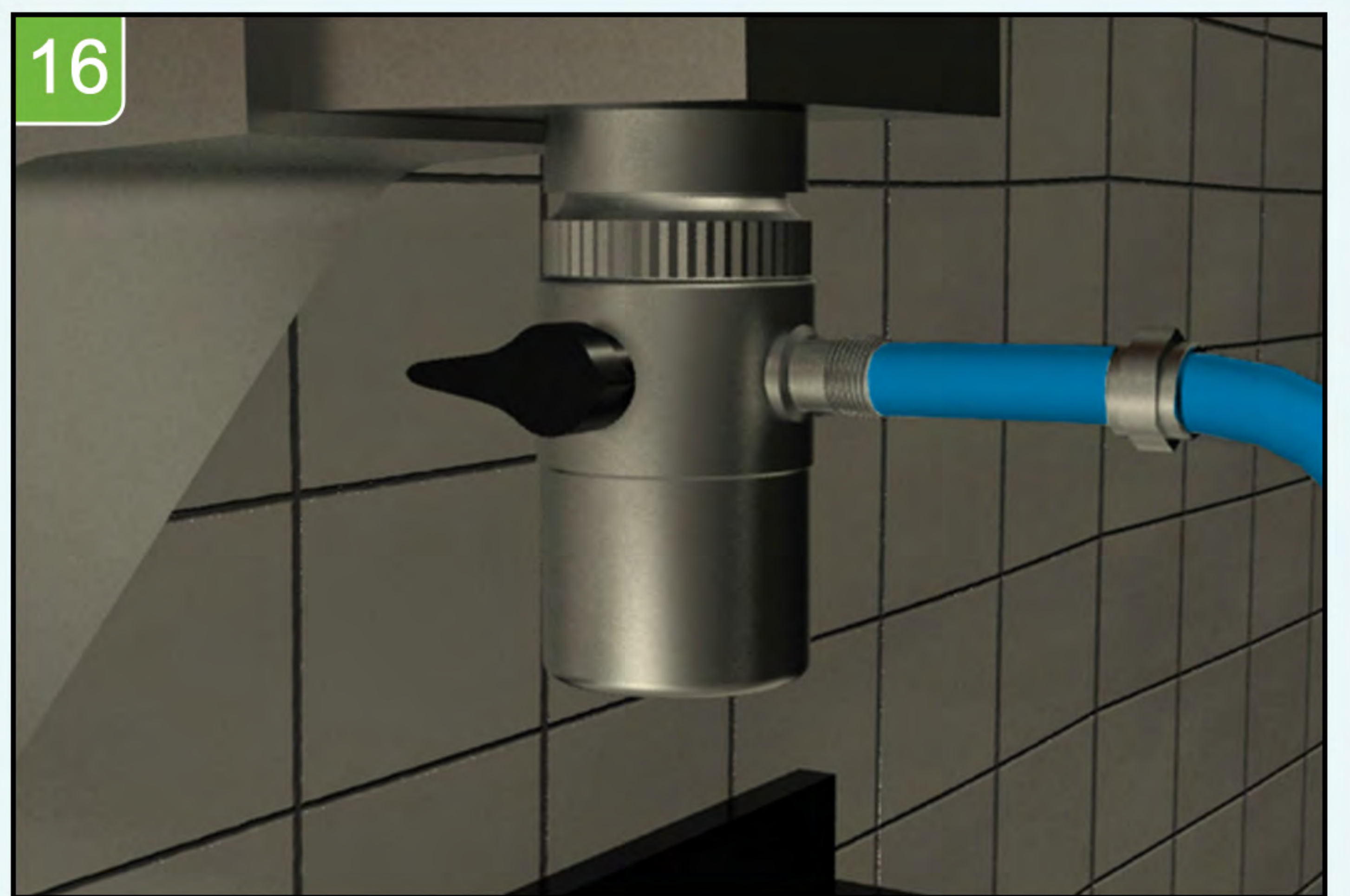
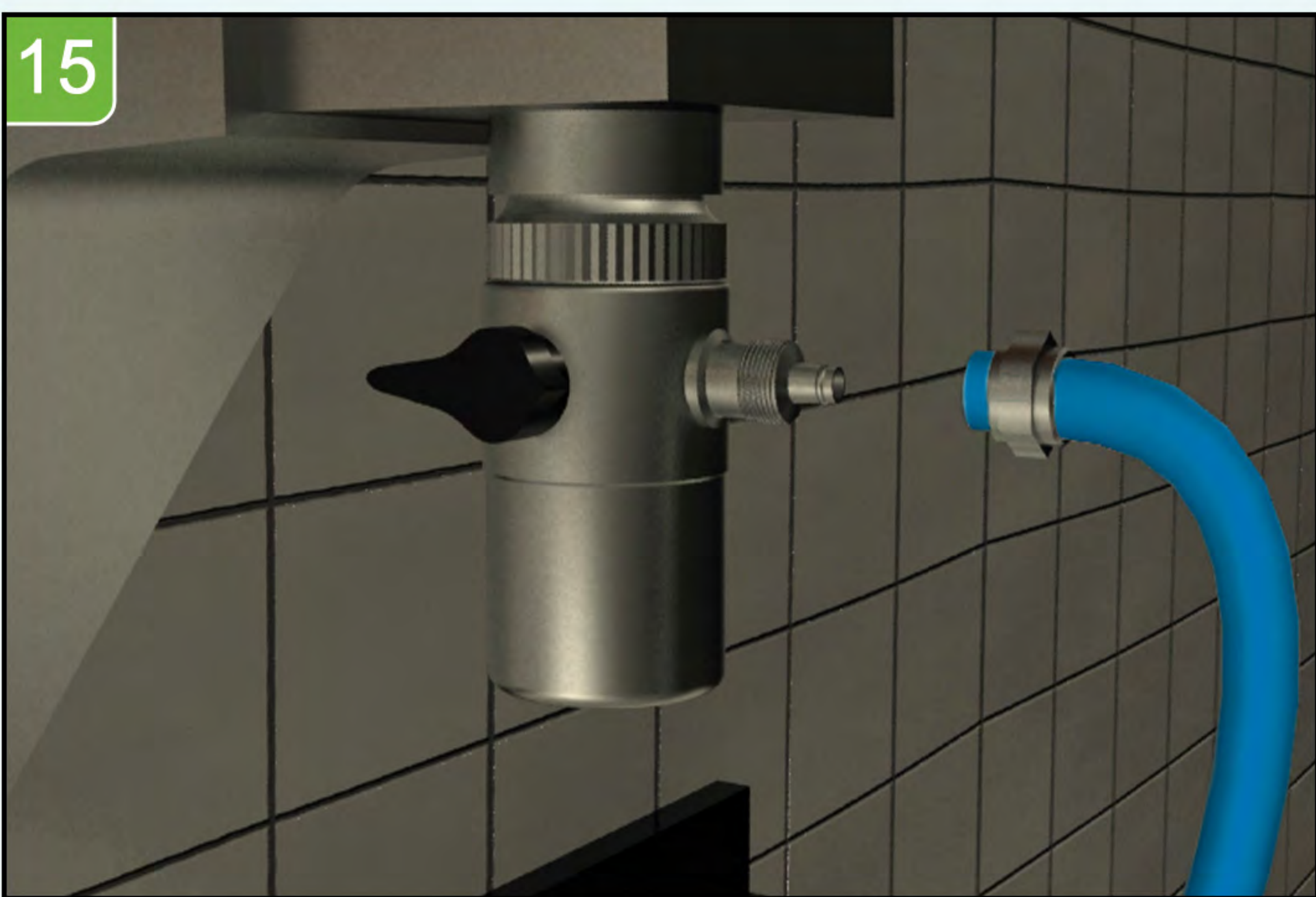
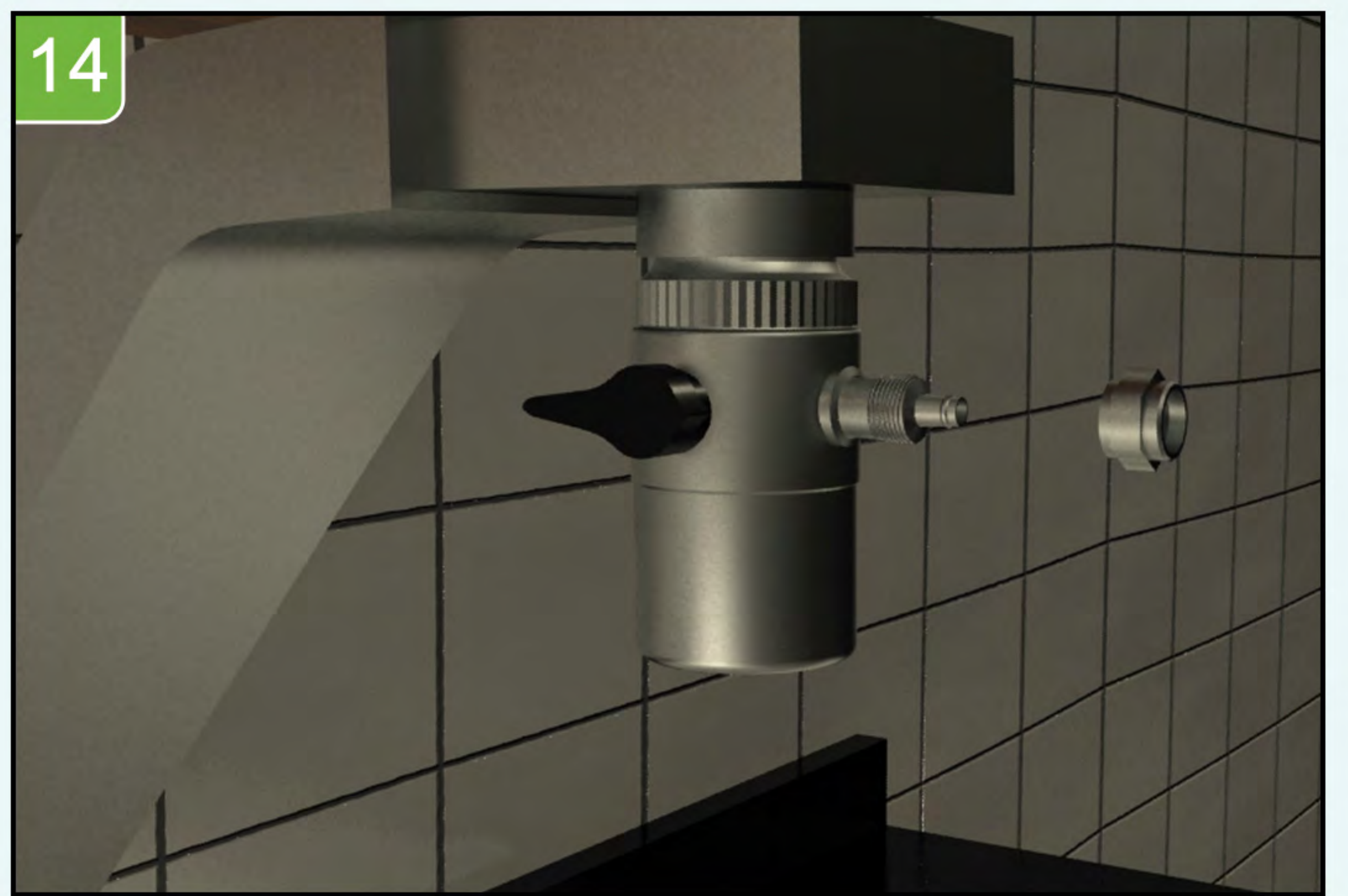
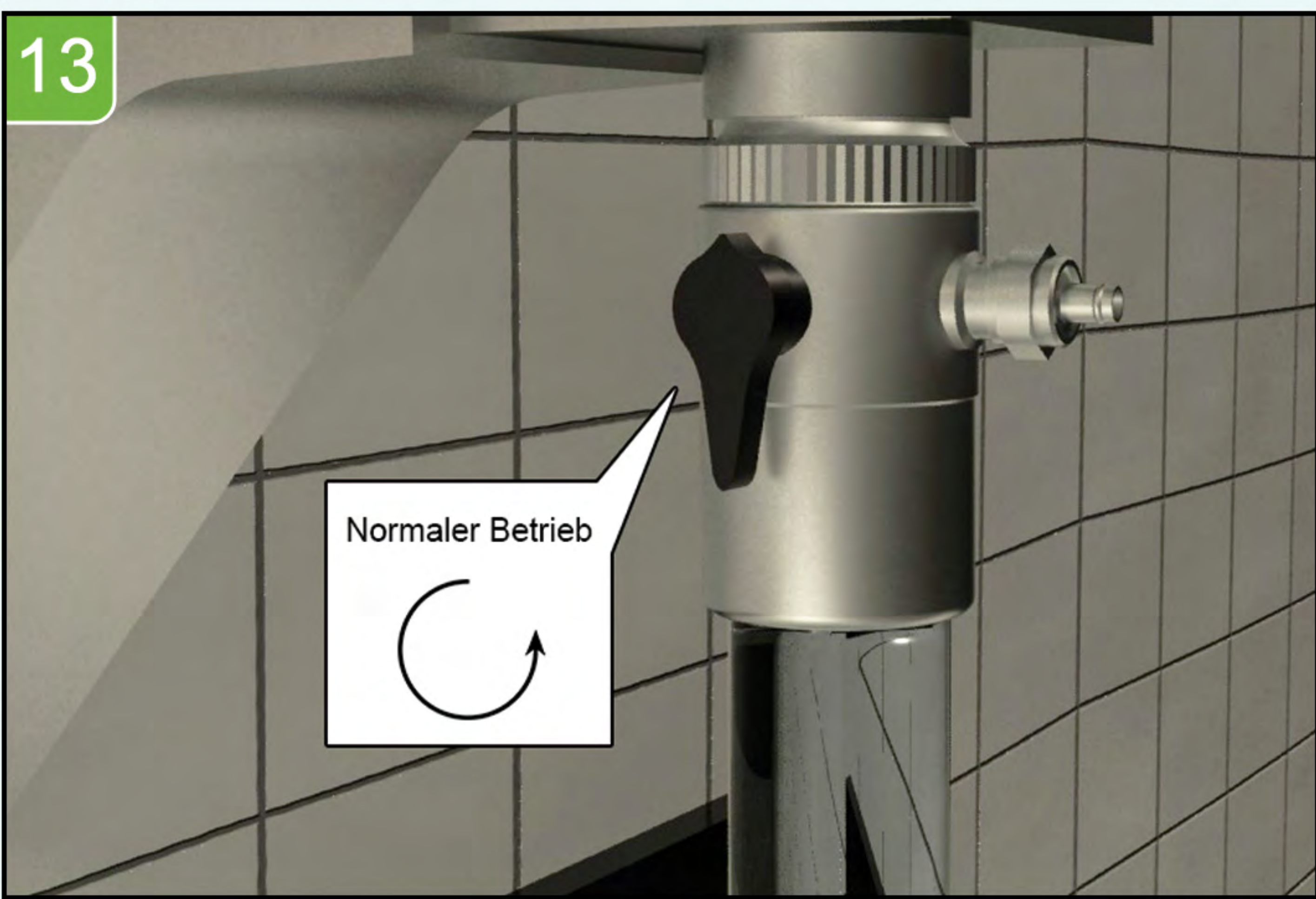
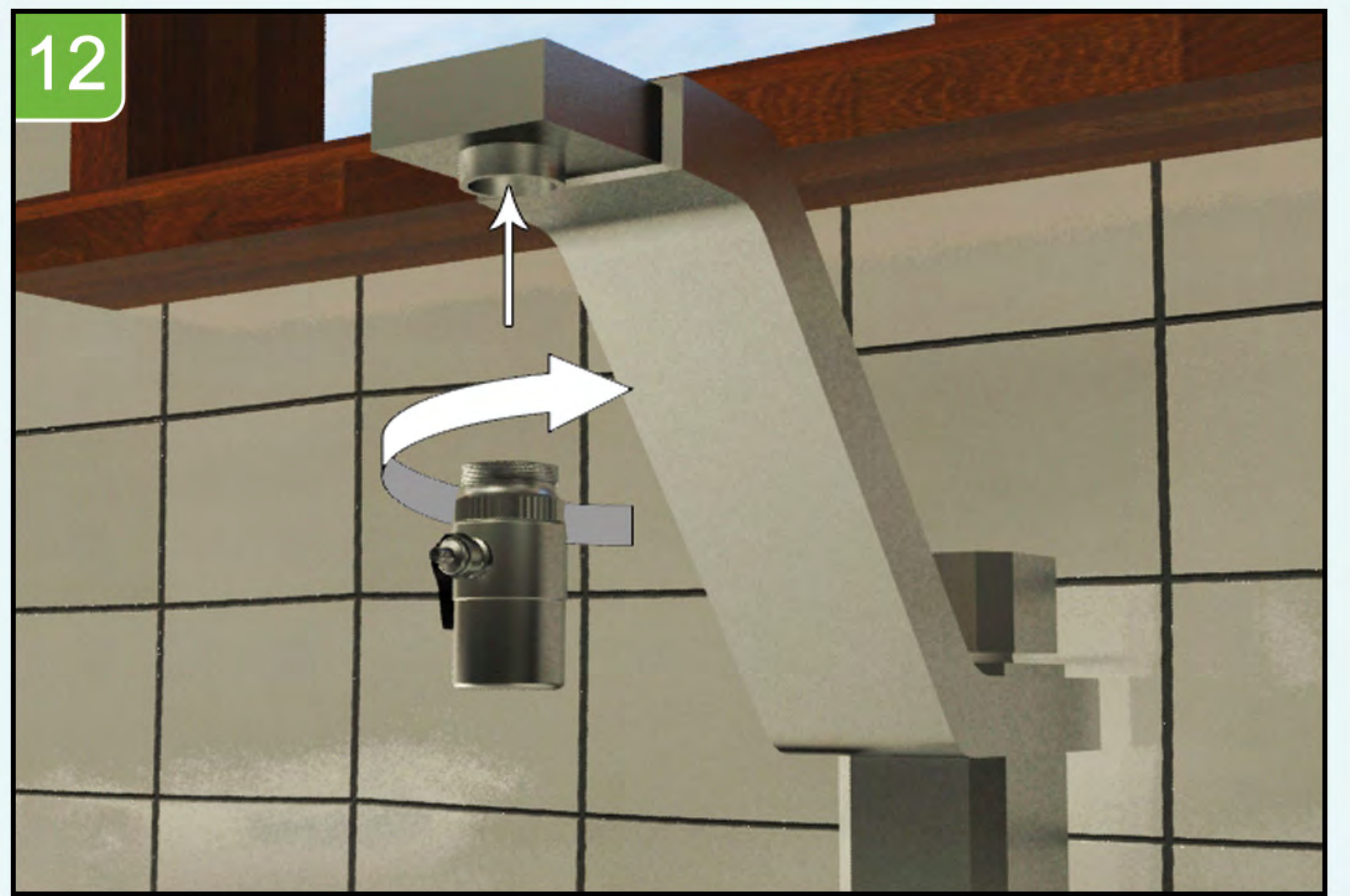
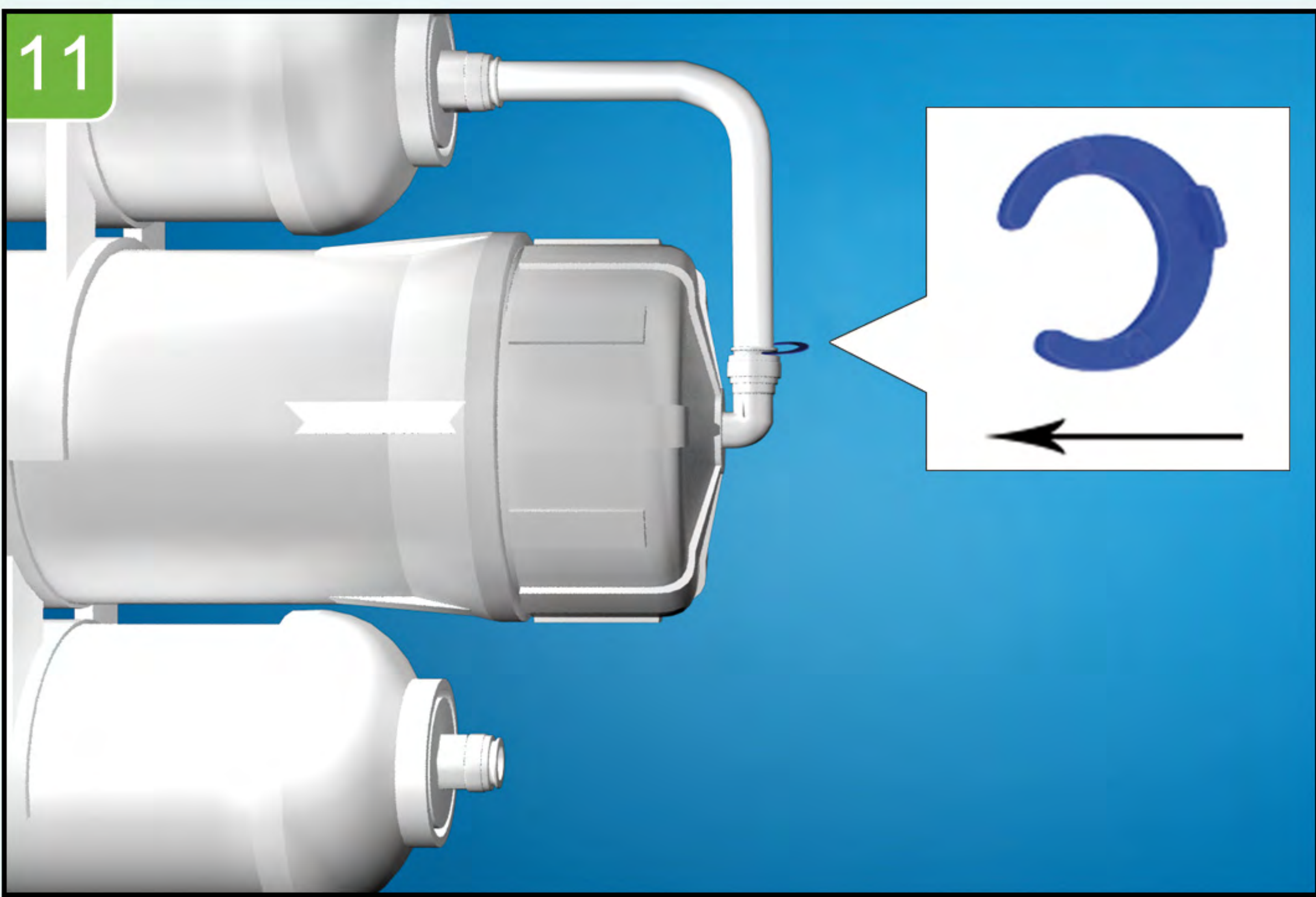
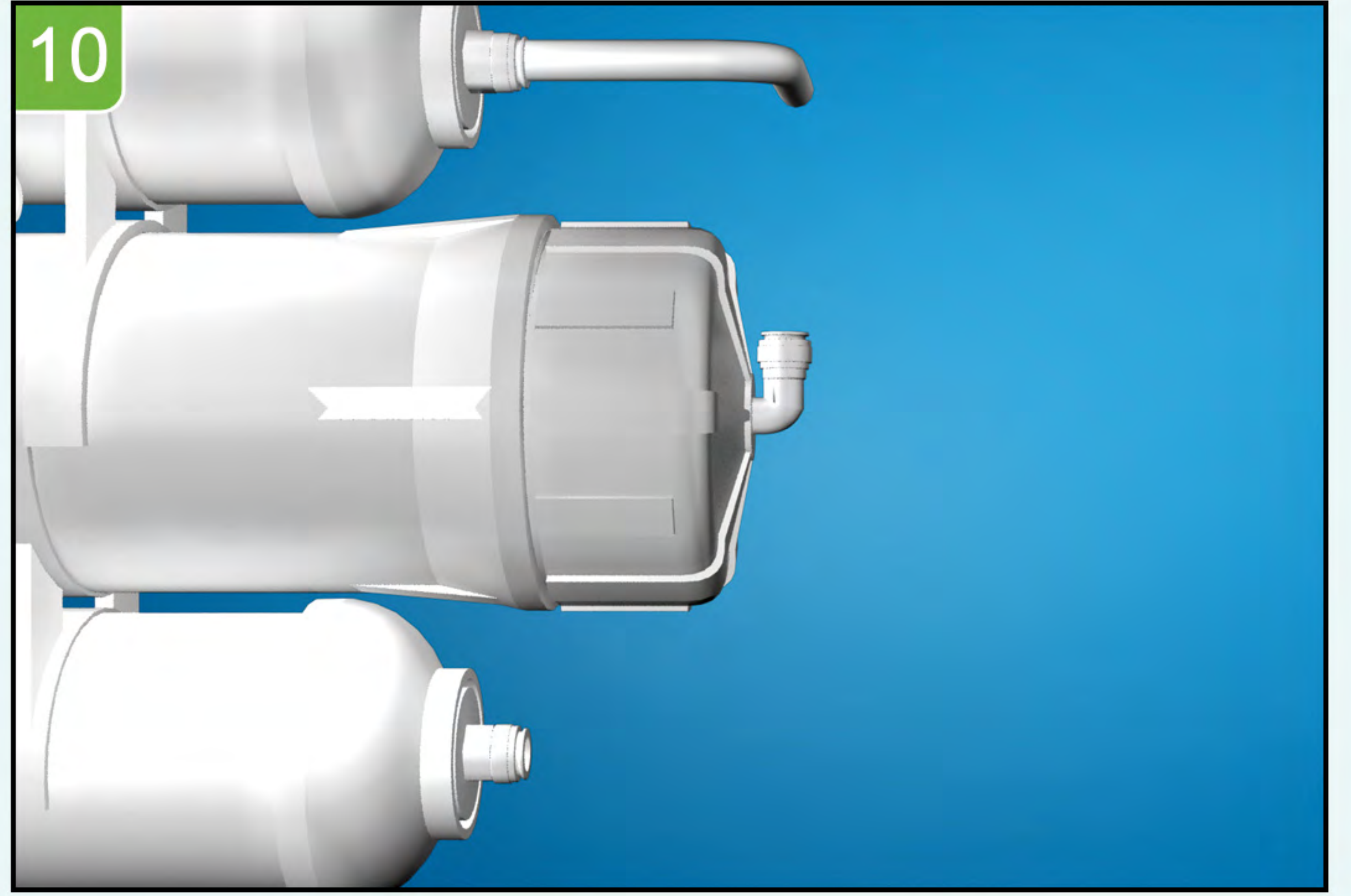
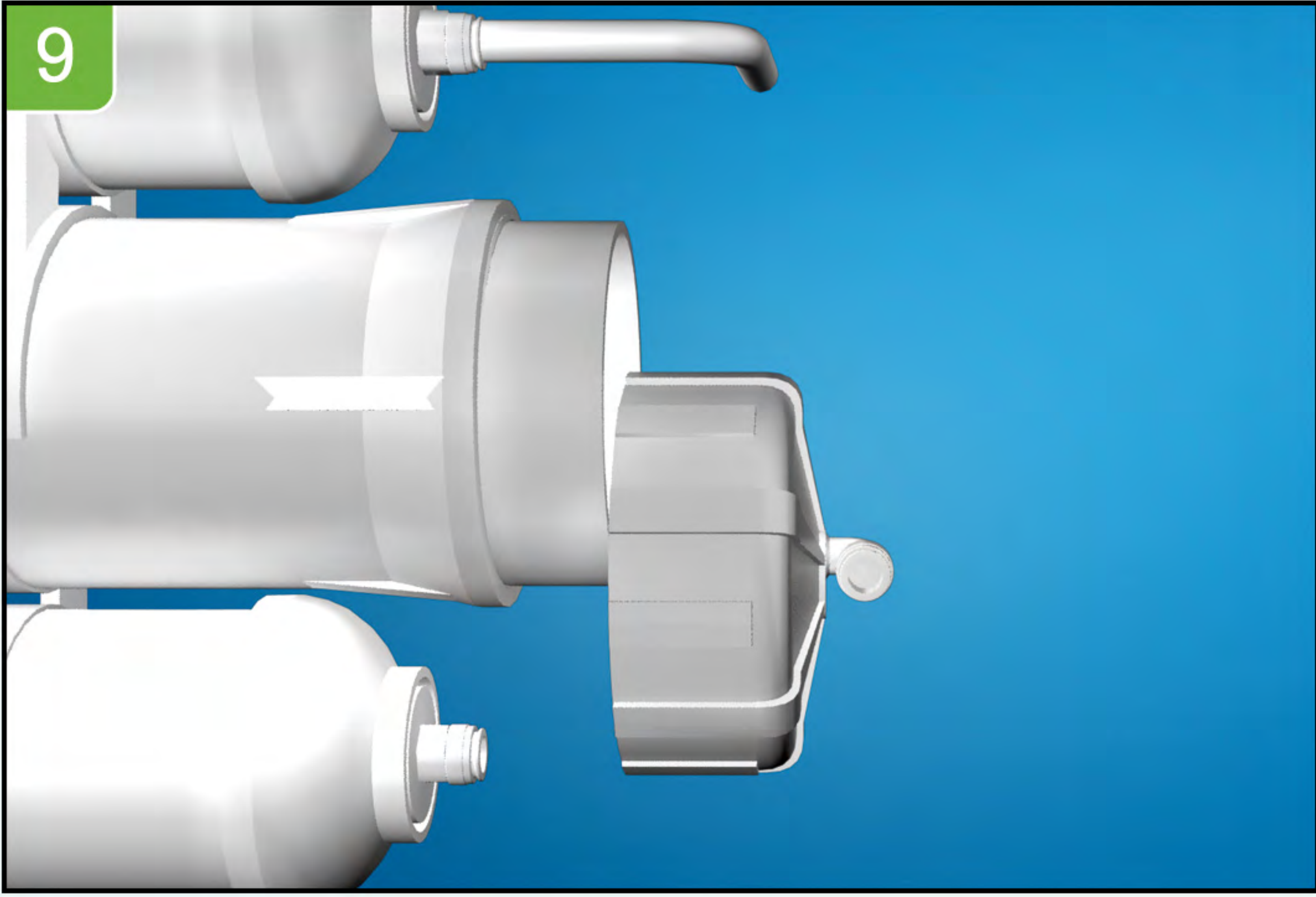



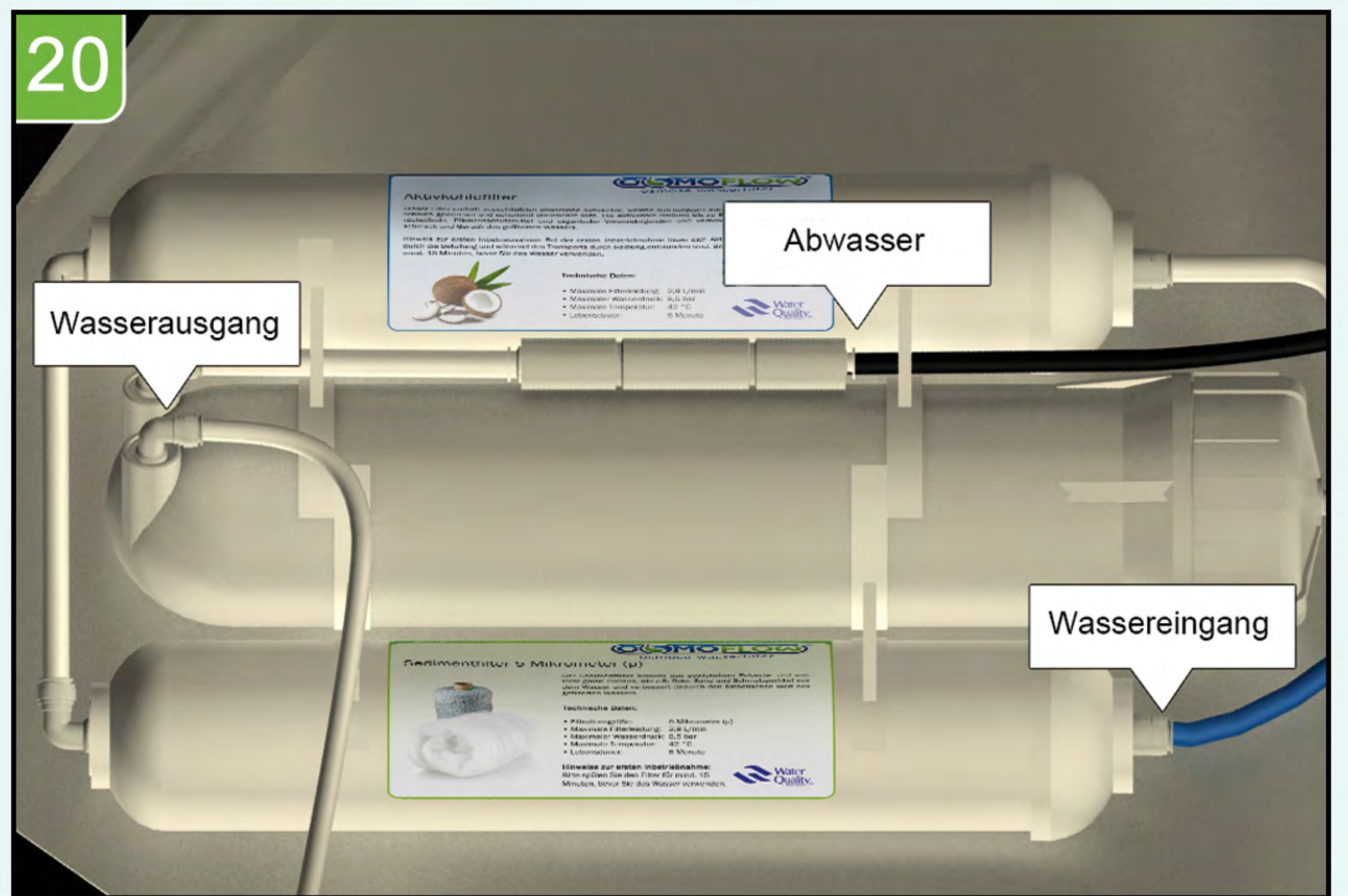
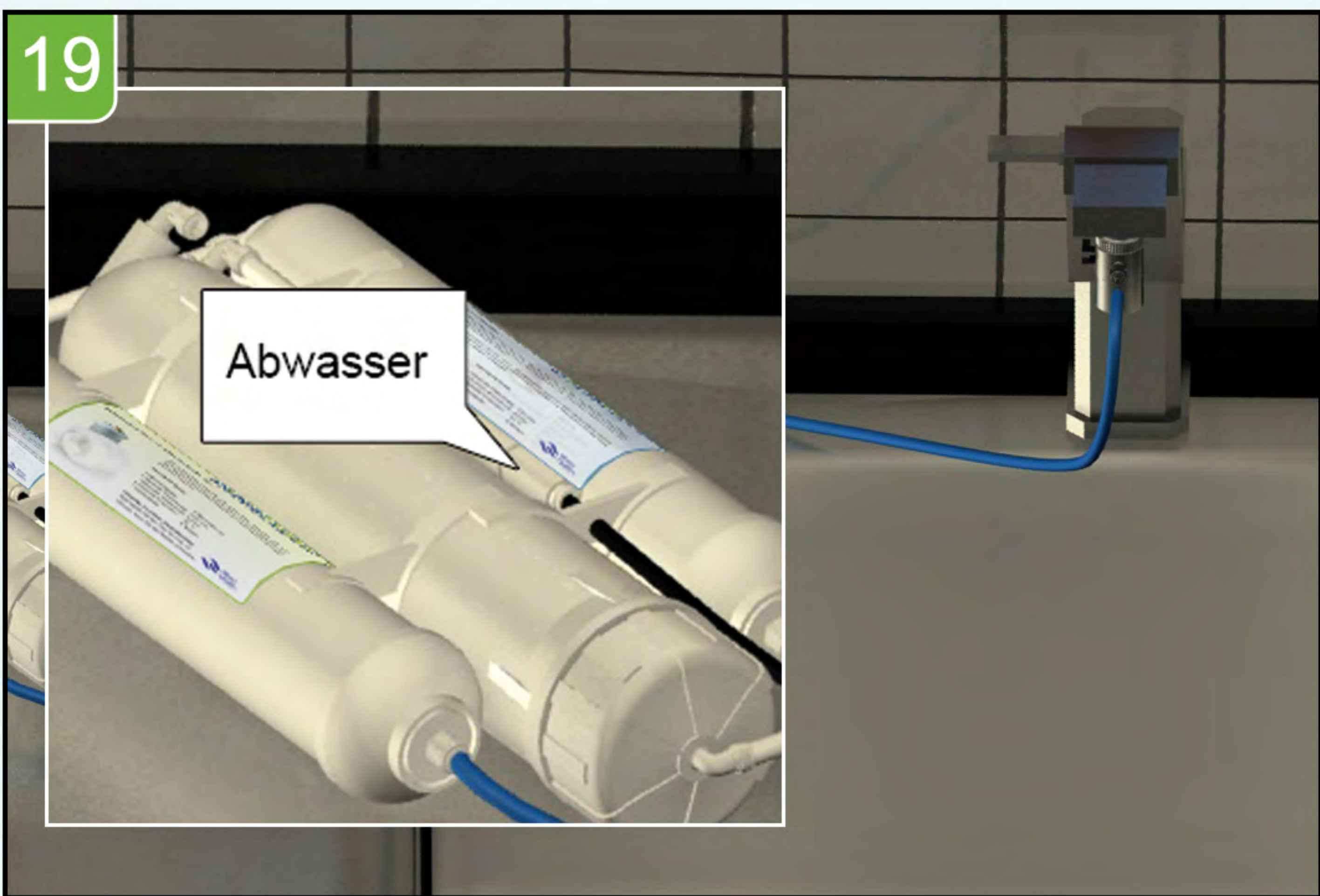
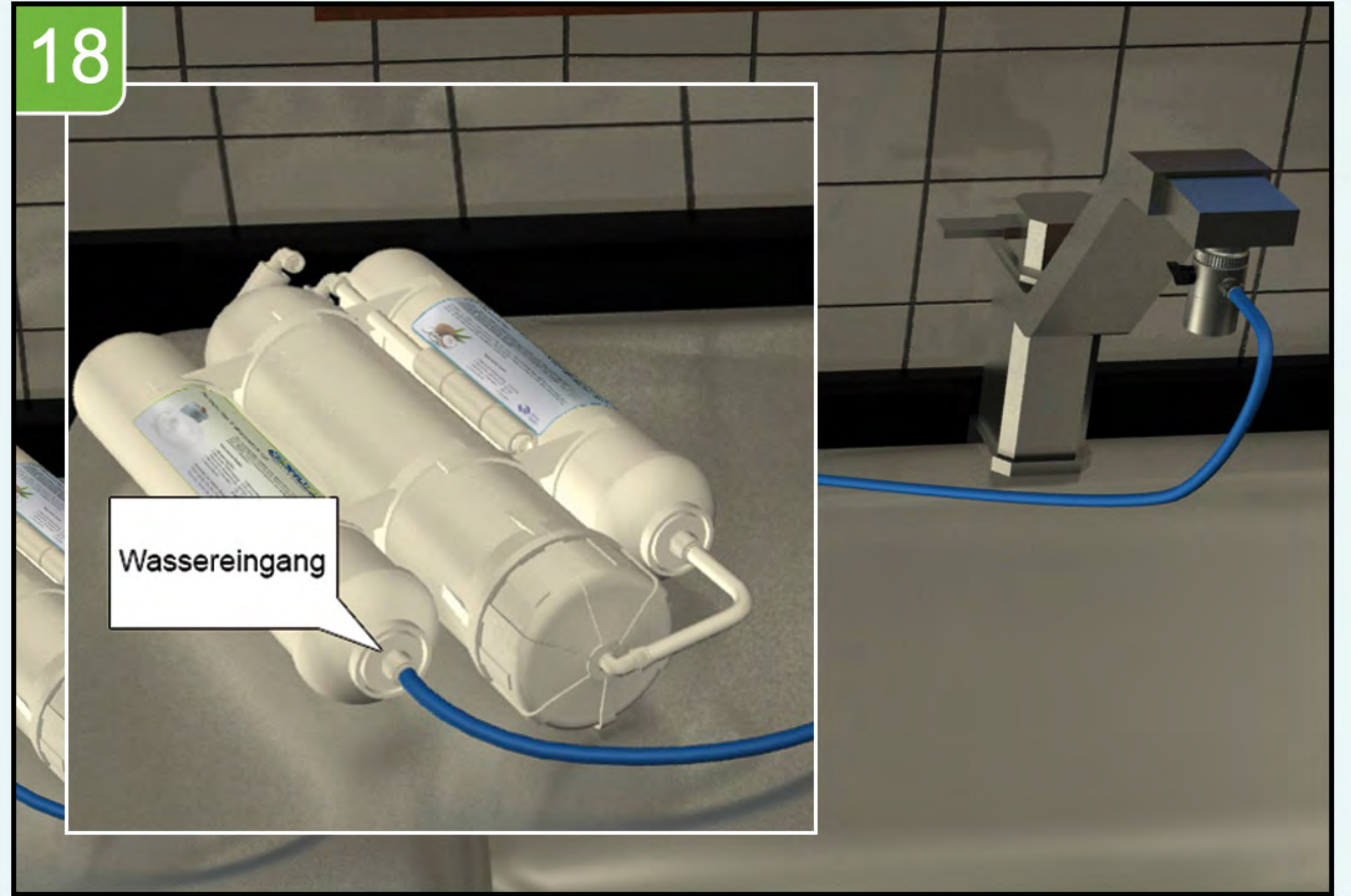
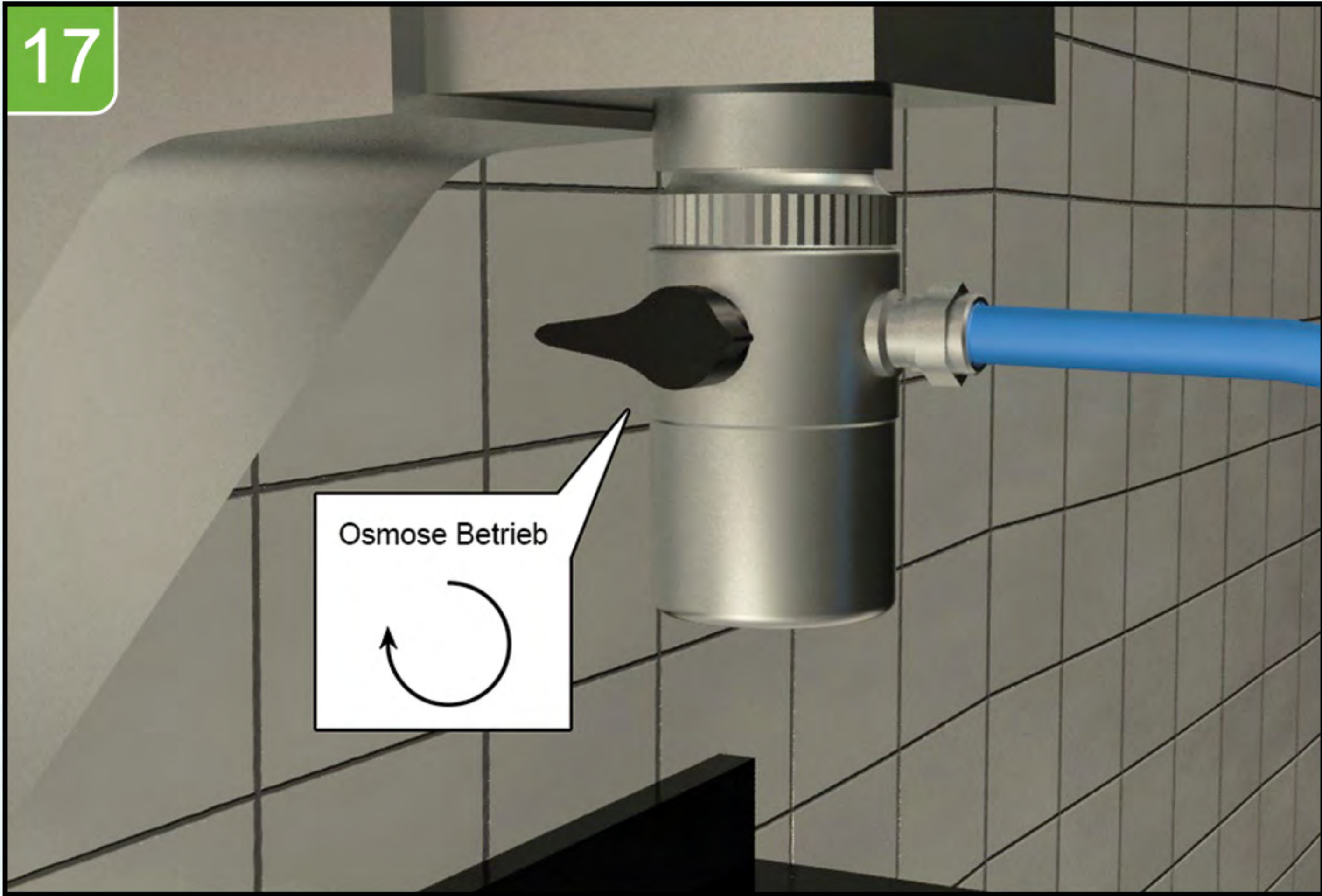



# Einzelteile im Überblick



1. Winkel 1/4 Zoll / Art.-Nr.: ZBH0010
2. Gerader Verbinder 1/4 Zoll / Art.-Nr.: ZBH0011
3. Schlauch 1/4 Zoll / Art.-Nr.: ZBH0013
4. Winkel mit integriertem Rückschlagventil / Art.-Nr.: ZBH0014
5. Winkel 1/4 Zoll / Art.-Nr.: ZBH0015
6. Durchflußbegrenzer Flow 300 / Art.-Nr.: ZBH0017
7. Doppelklammer / Art.-Nr.: ZBH0018
8. Membrangehäuse / Art.-Nr.: ZBH0019
9. Filterset / Art.-Nr.: ZBH0020



## Filterset ZBH0020



## Membrane 100 GPD

